

The image features a technical line drawing of a power amplifier chassis, shown from a perspective view. The chassis is rectangular with various components like capacitors, resistors, and connectors visible on its internal surfaces. The Cicada Audio logo is prominently displayed at the top left. The text 'BDA1000.4D', 'BDA1400.4D/BDA2000.4D', '4 CHANNEL POWER AMPLIFIERS', and 'Owners Manual' is overlaid on the drawing. A faint 'BDA1400' label is visible on the right side of the chassis.

CICADA
AUDIO

BDA1000.4D
BDA1400.4D/BDA2000.4D
4 CHANNEL
POWER AMPLIFIERS

Owners Manual



Congratulations, you have just purchased the finest Motorcycle Audio products on the market today. Cicada Audio products represent the latest advances in acoustic technology in sound reproduction for your Motorcycle applications. Cicada Audio products are designed, developed, and engineered using the latest innovative materials and components to provide the finest sound reproduction possible. Every Cicada Audio product has been Klippel verified and tested to ensure the best sounding and most reliable product on the market, if installed properly, Cicada Audio products will provide many years of the ultimate listening experience.

Please note that prolonged exposure to sound pressure levels in excess of 100dB can cause permanent hearing loss. Using Cicada Audio products can exceed that level so please exercise restraint in its operation in order to preserve your ability to enjoy its high fidelity sound for many years to come.

Cicada Audio recommends our products be professionally installed by an authorized Cicada Audio dealer to achieve the best possible system recommendation and installation. This will ensure a true Cicada Audio listening experience and sound you would expect from Cicada Audio products. In doing this you will extend your warranty from one year to two years.

BDA1000/1400/2000.4D - AMPLIFIERS

What comes in the package

- (1) Mounting Dual - Lock Velcro**
- (4) #6 - 1 inch Stainless steel sheet metal screws**
- (2) RCA Input Harness(es)**
- (2) Power and Speaker Allen Wrenches**

NOTE: there is a FULL "Plug & Play HD harness kit available from your local Cicada Audio retailer or from our website

RMS Power Rating	BDA1000.4D	BDA1400.4D	BDA2000.4D
Max Power	1000 W RMS	1400 W RMS	2200 W RMS
RMS Power (2 Ω)	250 W X 4	347 W X 4	542 W X4
RMS Power (4 Ω)	150 W X 4	217 W X 4	331 W X 4
Bridged (mono 1 Ω)	N/A	N/A	N/A
Bridged (mono 2 Ω)	N/A	N/A	N/A
Bridged (mono 4 Ω)	500 W X 2	700 W X 2	1044W X 2

(NOTE: ALL POWER RATINGS ARE PER CEA2006 12.5 Vdc AND IS APPROXMENTLY 17% LESS AND NOT NOTICEABLE AS THAT IS NOT 3dB DIFFERENT)

Type	Full Range Class D		
Topology	Full Range Class D	Full Range Class D	Full Range Class D
Power Supply	Full PWM		
Power Supply Threshold	10.0VDC - 17.0VDC	10.0VDC - 17.0VDC	10.0VDC - 17.0VDC
Idle Current	(1.2A)	(1.2A)	(1.2A)
Distortion	THD 4 (1KHz @4Ω) 0.5%		
S/N Ratio (A weighted @1W)	--85dBA	--85dBA	--85dBA
S/N Ratio (A weighted @ FP)	-101.1dBA	-101.1dBA	-91.1dBA
Input Sensitivity	Low Input Level 200mV - 12.0V		
High Input Level	N/A	N/A	N/A
Input Impedance	Low Input Level 20 KΩ		
AUX Input Level	20 KΩ	20 KΩ	20 KΩ
Output Stage	Output Impedance 0.0297 Ω		
Damping Factor (50Hz @ 4Ω)	>200	>200	>200
Bandwidth (-3dB)	10Hz-35KHz	10Hz-35KHz	10Hz-35Hz
Crossover (-12dB/Oct)	Variable High-Pass 30Hz - 300Hz		
Variable Low-Pass	30Hz - 300Hz	30Hz - 300Hz	30Hz - 300Hz
Variable Sub-Sonic	N/A	N/A	N/A
Fuse Ratings	MINI ANL 60A		
Dimensions	Lenght x Width x Height (inches) 6.8 x 5.37 x 2.1		
	Lenght x Width x Height (mm) 173 x 136.4 x 54		

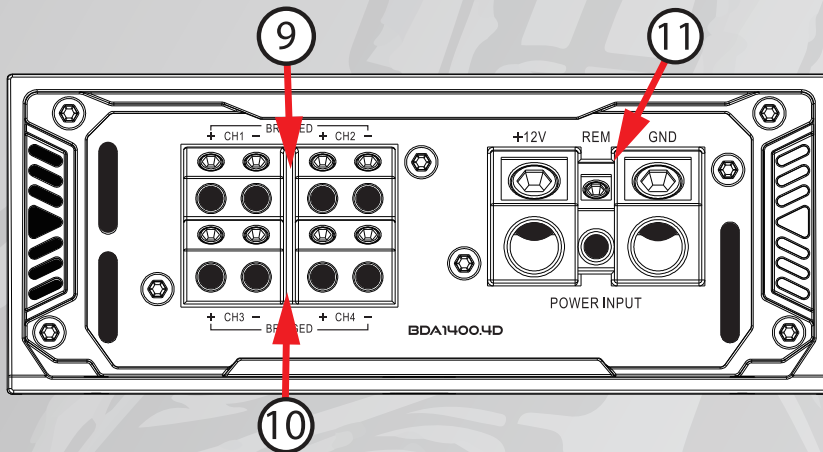
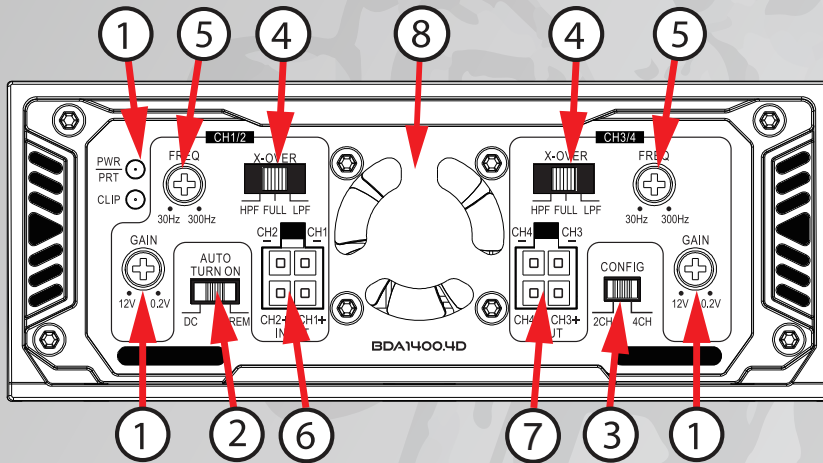

- 1 PWR/PRT LED - This light indicate when the amplifier is powered up normally and when there is a protection fault. The Protect LED is illuminated when there is a problem with your amplifier. Please contact your authorize Cicada Audio dealer or call Cicada Audio's technical support.
- 2 GAIN (Input Gain Adjustment) - This control matches the preamp INPUT stage of the Cicada Audio amplifier to your source unit. This is NOT a volume control. The range is between approximately 200mV and 10V. It can ALSO handle speaker inputs of less than 25 watts RMS (typical OEM headunits are LESS than 25 W RMS,...but NOT all)
- 3 TURN-ON OPTIONS - The Cicada Audio amplifiers can be switched on and off using one of two methods, determined by the position of the amplifier's "Turn-On Mode" switch. Please read the "Set-Up " portion of this guide and determine which is best suited for your specific system. NOTE: DC turn-on settings ONLY work with speaker level input.
- 4 LPF/FULL/HPF Crossover Adjustment - Use this adjustment to select the crossover function. Either Low Pass (LPL) or High Pass (HPL) or FULL (Full Range)
- 5 Crossover Adjustment - Use this adjustment to select the crossover point. Remember that you must select the Low Pass position (LPF) of the crossover adjustment switch first. The range of adjustment is limited between 40-400 Hz (12dB per Octave)
- 6 Front RCA Input Terminal (CH1 /2) - The RCA jacks allow for a normal Left and Right channel signal input. Simply connect to the source unit using RCA type audio cables, keeping them away from power wiring wherever possible to reduce risk of noise. NOTE: This input can be used for "speaker level" input by using the optional Speaker Hanress HDFIM/HDRIM (with load resistors), or by simply cutting and attaching OEM head unit speaker outputs to these wires. Or cut up an old RCA cable and connect your HD radio speaker wires that way (Better solution)
- 7 Rear RCA Input Terminal (CH3 /4) - The RCA jacks allow for a normal Left and Right channel signal input. Simply connect to the source unit using RCA type audio cables, keeping them away from power wiring wherever possible to reduce risk of noise. NOTE: This input can be used for "speaker level" input by using the optional Speaker Hanress HDFIM/HDRIM (with load resistors), or by simply cutting and attaching OEM head unit speaker outputs to these wires.
- 8 Thermal Controlled Fan - 3 Speeds. As temerature rises, fan speed increases to accomadte the increased heat.
- 9 Front Speaker Output Terminal - Connect your Front speakers to these wires. Stereo connections are connected as labeled. Bridged connections use the LEFT + and RIGHT - as the two connections. The 2 and 4 channel amplifiers will perform into 2 Ohm stereo loads or 4 Ohm bridged loads. DO NOT run 2 Ohm bridged loads on AND Cicada Audio amplifiers. They will work, but will over heat very quickly.
- 10 Rear Speaker Output Terminal - Connect your Rear speakers to these wires. Stereo connections are connected as labeled. Bridged connections use the LEFT + and RIGHT - as the two connections. The 2 and 4 channel amplifiers will perform into 2 Ohm stereo loads or 4 Ohm bridged loads. DO NOT run 2 Ohm bridged loads on AND Cicada Audio amplifiers. They will work, but will over heat very quickly.
- 11 Power Input Connections - These connections are for input power(12V), chassis ground (GRD), and remote(REM) turn-on. Use a minimum of 8 gauge wiring for power and ground connections. The terminals will handle up to 8 gauge wiring with no problem what so ever. Be sure any wiring that passes through metal has a grommet!



DIMENSIONAL DRAWINGS FOR FITMENT (FOR BDA1000.4D/BDA1400.4D OR BDA2000.4D)

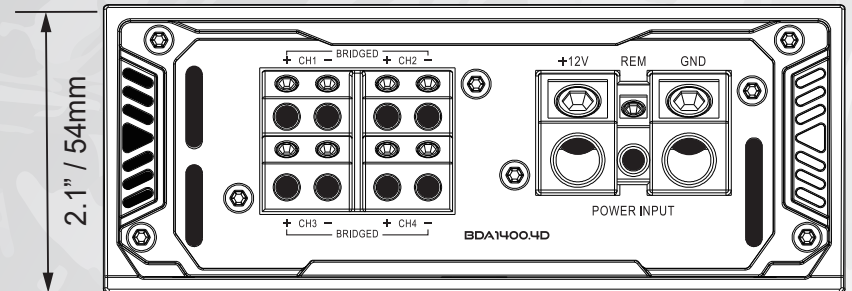
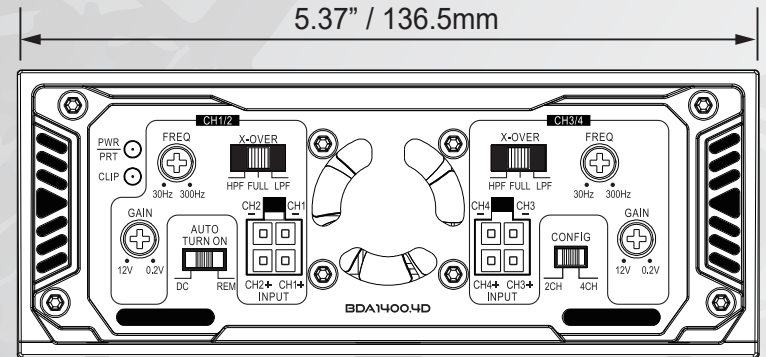
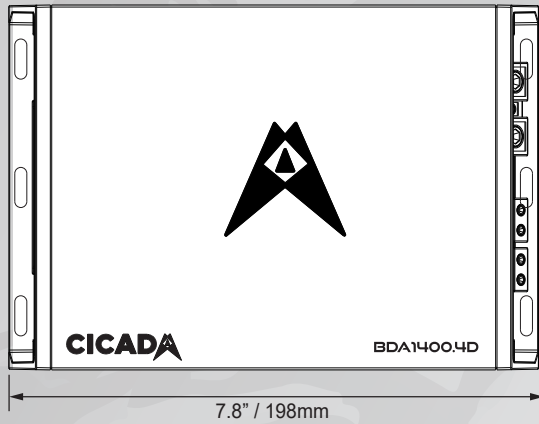
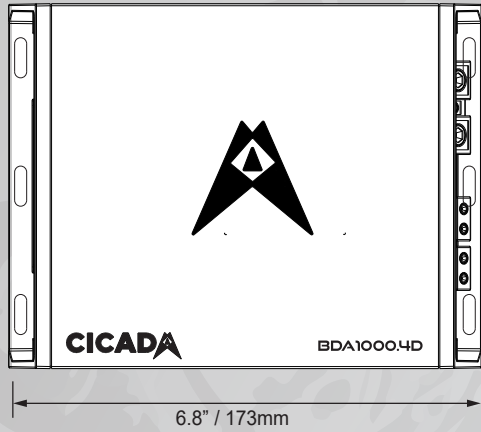

WARNING: Prolonged exposure to sound pressure levels in excess of 100dB can cause permanent hearing loss. Diamond Audio amplifiers can exceed that level so please exercise restraint when listening and enjoying your new amplifier.

GENERAL PRECAUTIONS

- This unit is designed for negative ground 12V DC operation only.
- Total system impedance must not be less than 2ohms, in a bridged OR stereo configuration
- Avoid installing the unit where:
 - It would be subject to high temperatures, such as from direct sunlight or hot air from the heater.
 - It would be exposed to rain or moisture.
 - It would be subject to dust or dirt.
- Do not cover the unit with carpet or wires.
- Do not use the unit with a weak auto battery. Optimum performance depends on a normal battery supply voltage.
- For safety reasons, keep the volume of your car audio system moderate while driving your vehicle so that you can still hear normal traffic sounds outside your car.
- There is NO speaker level input connector, you can cut RCA's and solder the wires and connect directly thru low level input(RCA)

MOUNTING PRECAUTIONS

Although CICADA AUDIO amplifiers incorporate heat sinks and protection circuits, mounting the amplifier in a tight space without any air movement can still damage internal circuitry over time. Choose a location that provides adequate ventilation around the amplifier. For easy system set-up, mount the amplifier so the side panel controls will be accessible after installation. To increase thermal run times on low impedance loads, an additional fan is recommended, remember any moving air across the amplifier will reduce heat.

In addition, observe the following precautions:

1. Using a felt pen mark the mounting hole locations.
2. Mounting the amplifier on carpet will significantly reduce air flow, resulting in reduced thermal run times.
3. Mount the amplifier on a solid surface. Avoid mounting to sub woofer enclosures or areas prone to vibration. Do not install the amplifier on plastic or other combustible materials.
4. Prior to mounting the amplifier, make sure not to cut or drill into the fuel tank, fuel lines, brake lines (under chassis) or electrical wiring.

WIRING PRECAUTIONS

1. Before installation, make sure the source unit power switch is in the OFF position.
2. Disconnect the negative (-) lead of the battery before making any power connections.
3. When making connections, be sure that each one is clean and secure. Insulate all of your connections. Failure to do so may damage your equipment.
4. A secure clean ground connection is critical to the performance of your amplifier. Connect the ground directly to the car chassis to minimize resistance and avoid any noise problems.
5. Add an external fuse on the amplifier's positive (+) power lead and connect it as close as possible to the vehicle's (+) battery terminal. Use a rating that equals the total current consumption at full output of all amplifiers in the system. This external fuse will protect the vehicle from short circuits that can cause a fire.

Fuse rating as follows: BDA1000.4D - 1000 W RMS = 60A

BDA1400.4D - 1400 W RMS = 80A

BDA2000.4D - 2000 W RMS = 120A

(THESE ARE SUGGESTED FUSE SIZES BASED ON FR CLASS D EFFICENTCY)

BDA1000/1400/2000.4D - 4 CHANNEL WIRING SPEAKER OUTPUT

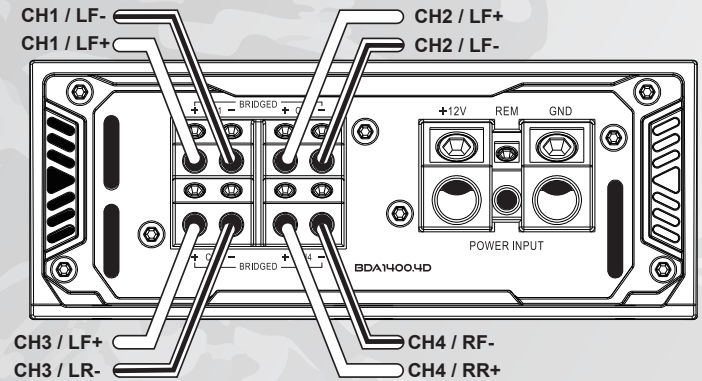

BRIDGING INPUT FROM OEM HD RADIO

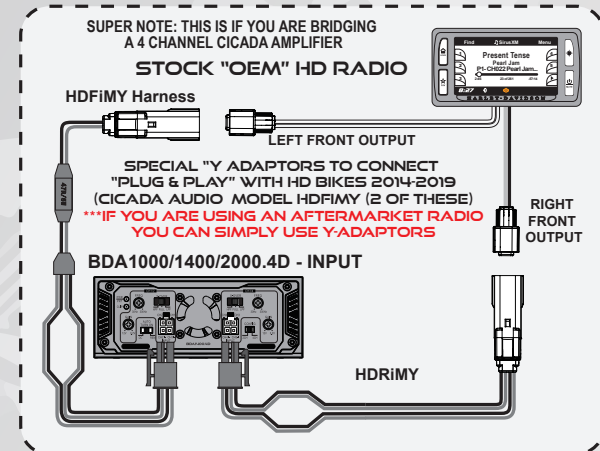

BRIDGING 4 CHANNEL AMPLIFIER OUTPUT TO 2 CHANNEL

SUPER NOTE: 4 CH AMPLIFIER BRIDGED ONLY USES 4 OF THE 8 WIRES AS SHOWN!!!

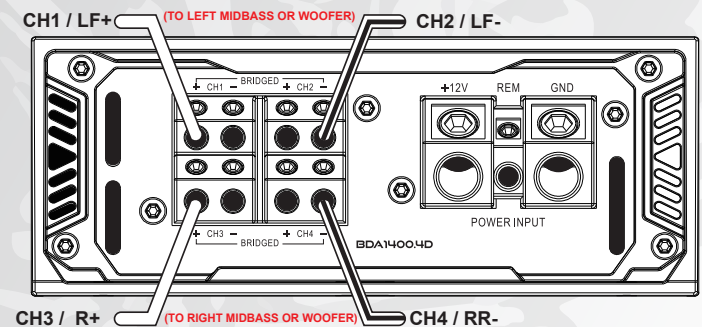



VEHICLE ELECTRICAL SYSTEM

Amplifiers (regardless of brand name) will put an increased load on the vehicle's battery and charging system. CICADA AUDIO recommends checking your alternator and battery condition to ensure that the electrical system has enough capacity to handle the increased load of your stereo system. Original equipment electrical systems, which are in good condition, should be able to handle the extra load of "MOST" CICADA AUDIO amplifier without problems, although battery and alternator life can be reduced depending on your individual listening habits.

WARNING:

Avoid running power wires near the low level input cables, antenna, power leads, sensitive equipment or harnesses. The power wires carry substantial current and could radiate noise into the audio system through the audio cables. **4 GAUGE OR LARGER POWER/GROUND WIRE!!!**

INSTALLATION:

1. Plan the wire routing. Keep RCA cables close together but isolated from the amplifier's power cables and any high power auto accessories, especially electric motors. This is done to prevent coupling the noise from radiated electrical fields into the audio signal. When feeding the wires through the any metal barrier or tubing , protect them with plastic or rubber grommets to prevent short circuits. Leave the wires long at this point to adjust for a precise fit at a later time.
2. Prepare the power wire for attachment to the amplifier by stripping 5/8 inch (15.9mm) of insulation from the end of the wire. Insert the bare wire into the removable B+ terminal And tighten the set screw to secure the cable in place. Do the same for Ground and Remote. (unless you are using DC Offset then DO NOT have the REM wire connected!!!!) Make sure the ground is clean, with no paint,dirt or grease. Strip the other end of the ground wire, crimp and solder a ring connector. Fasten the ground cable to the battery directly is always the preferred install guidance.

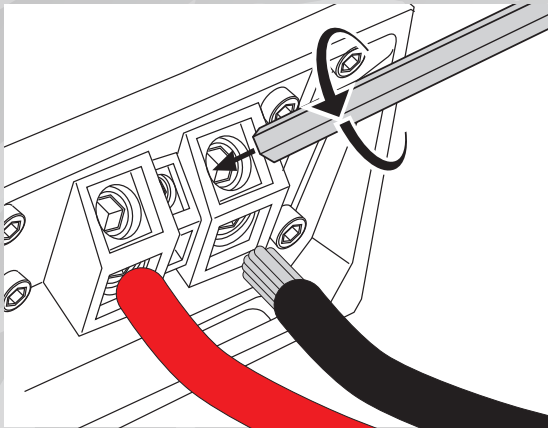

WARNING:

The B+ cable **MUST** be fused 18" or less from the bikes's positive battery post. Choose a location to install a waterproof fuse holder in the frame and ensure connections are watertight. If you do not use the appropriate fuse holder, the connection will eventually suffer corrosion from moisture and heat.

3. Trim the power cable within 18 inches (45.7mm) of the positive battery post and splice in a in-line fuse holder. **DO NOT** install the fuse at this time.
4. Strip 1/2 inch (12.7mm) from the battery end of the power cable. Crimp and solder a large ring terminal to the cable. Connect the ring terminal to the positive (+) battery post.
5. Securely mount the amplifier to the bike. We've included industrila grade "velcro" to make it easier and more effective mounting technique. Peel the sticky back tape off and stick to a flat surface. Usually it is best to but the male/female parts together and stick to the amp, then peel off the remaining sticky back tape and stick to the bike under the fairing, or in the bag. Lots of options. Or screw it down if that makes you feel safer. But after 1,000's of these type amplifiers being mounted with Dual Lock velcro type tape, I've seen **NO** issues.

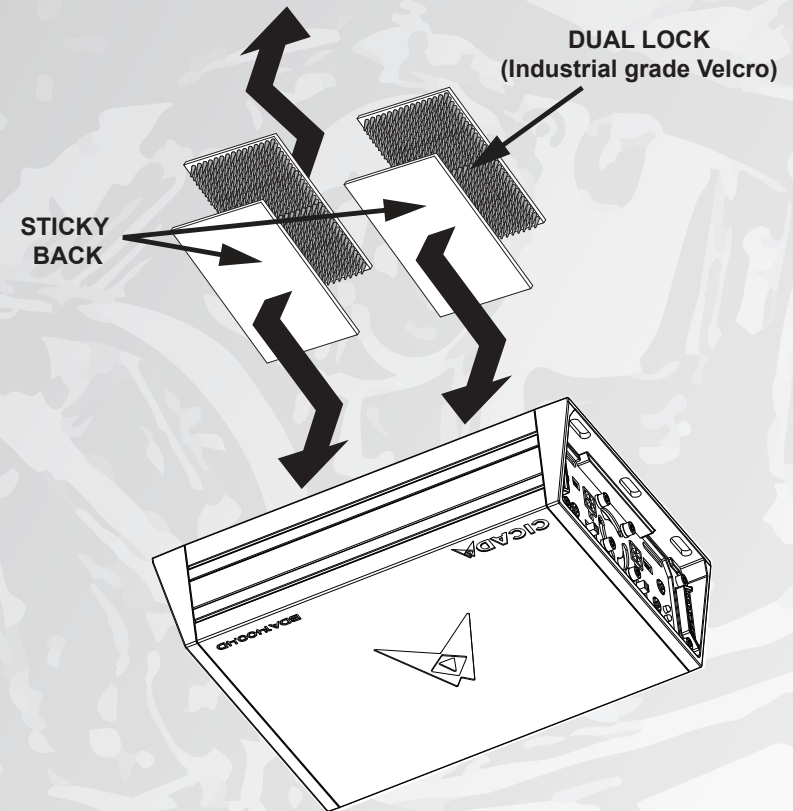



6. If you decide on using a “hard” 12 volt turn on, Prepare the REM turn-on wire for attachment to the amplifier by stripping 5/8 inch (15.9mm) of insulation from the end of the remote turn-on wire. Insert the bare wire into the REM terminal and tighten the set screw to secure the wire in place. Connect the other end of the REM wire to a switched 12 volt positive source. The switched voltage is usually taken from the source unit’s remote amp turn on lead. If the source unit does not have this output available, the recommended solution is to wire to the ignition switch of the bike to the amplifier. This however will turn the amplifier on and off with the ignition key, regardless of whether the radio is on or off. If you get turn on “pops” and/or turn OFF pops, it will be cause by this remote trigger.

TURN-ON CONFIGURATOR

Use the DC offset selection shown and disconnect the hard wired REM wire.

DC TURN-ON SELECTED

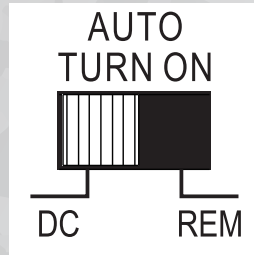

REM TURN-ON SELECTED

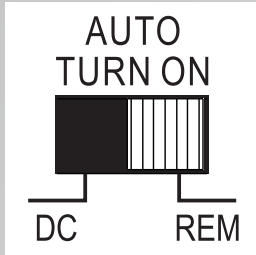

Using the REM selection shown you must hard wire a switched 12V wire

SETTING CROSSOVER TO PROTECT YOU SPEAKERS

Set crossovers first to protect you speakers during initial setup. Placing the x-over switch in the FULL position sets the amplifier to Full Range. This setting allows ALL frequencies to pass to the speakers. With either the CX150.4D/CX250.2D placing the switch in the HPF or LPF position activates the 12dB crossover. Placing the switch in the HPF position sets the amplifier to the High Pass Filter mode, enabling

FILTER SELECTOR (HPF - Hi Pass Filter)

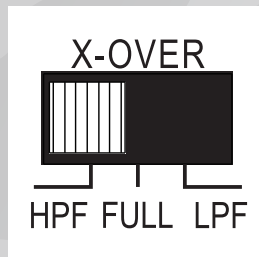

FREQUENCY SELECTOR

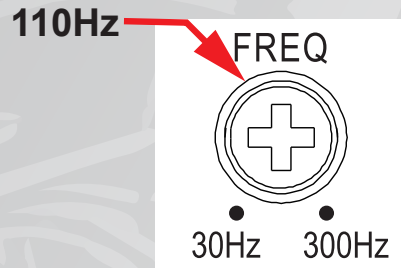

Placing the switch in the LPF position sets the amplifier to the Low Pass Filter mode, enabling frequencies below the cutoff point to pass. For a subwoofer system begin tuning with the frequency set between 40Hz and 80Hz. To adjust the gain setting, turn the amplifier gains all the way down (counterclockwise). Next turn the source unit volume up to almost full volume (usually about 2/3rds of the way up) or until the output starts to distort on an oscilloscope. This will be NEARLY full volume on most source units, perhaps one or two “clicks” down from maximum volume. Next, increase the amplifier gain setting until adequate volume is achieved, or until distortion is audible and then turn it down a bit until the distortion is inaudible.

FILTER SELECTOR (LPF - Lo Pass Filter)

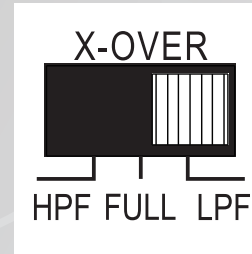

FREQUENCY SELECTOR

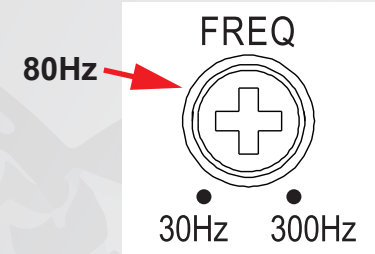

NOTE:

Ideal signal to noise and dynamic range are achieved with the gain at minimum. Most users find adequate gain and volume is achieved at less than halfway in the adjustment range. Avoid setting the amplifier gain very high as noise and distortion will increase significantly. For a more in depth level setting (gain adjustment) procedure, visit the CICADA AUDIO website SUPPORT PAGE as there is a tutorial on setting gain.

DSP AND BEYOND!!

My basic assumption is that MANY people will be using a DSP of some type with these amplifiers. It is TOO easy to build “KILLER” systems simply by using our products. But here is the deal. If you are going to use a DSP than all filters are set to FULL. Or “All pass” as it is really known as. Gains for ANY High Pass (HPF) speaker (like CH or CX series Cicada Audio speakers) should be “Pre-set” at about “10 O-Clock”, Lo Pass (LPF) Pre-Set gain at about “12 O-Clock”

PRE-SET HI-PASS GAIN

10 “O-CLOCK”

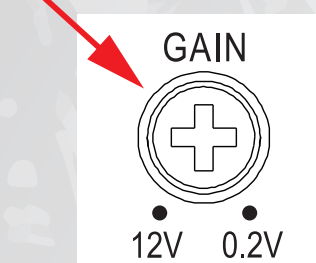

PRE-SET LO-PASS GAIN

12 “O-CLOCK”

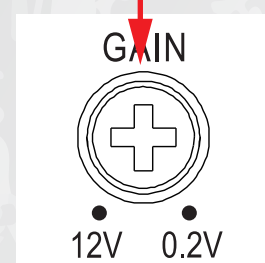

From this point on ALL setup - gains, crossover frequencies, delay, etc needs to be done at the DSP. The amplifiers are JUST amplifiers. NO signal processing happens there!!!



4 CHANNEL / 1 AMP SYSTEM W / COAX HORNS

1 - 4 CHANNEL AMPLIFIER / 4 COAX HORNS

“NO FADE!! 2 CHANNEL INPUT

IN FAIRING

CH65.2 - 2 ohm - 6.5" CoAx Horns

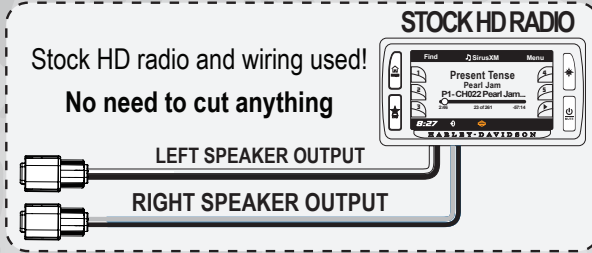
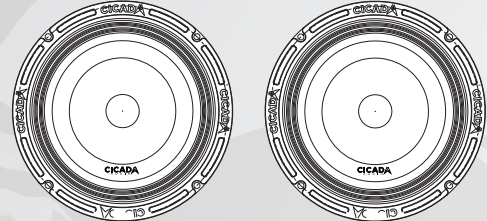

Part# HDFiM OPTIONAL:
FRONT INPUT WITH HD MOLEX
WITH 47 OHM RESISTOR

NOTE: This system has NO FADE capability! To do that (fade) you need to connect the rear speaker out of your stock HD radio. This typically means you need to “flash” your bike to get the rear channels to function

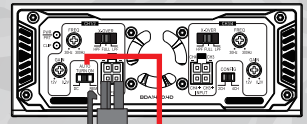

Part# HDFoM OPTIONAL:
FRONT SPEAKER OUTPUT
WITH HD MOLEX

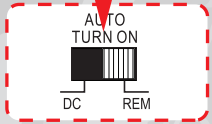
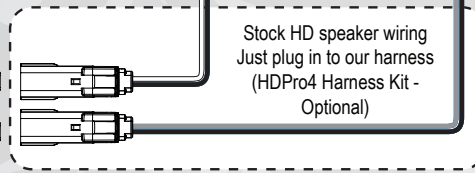

WITH NO SWITCHED 12V REMOTE OUT
USE “VOX” AS THE TURN ON SELECTION

BDA1000/1400/2000.4D AMPLIFIER
OUTPUT SIDE

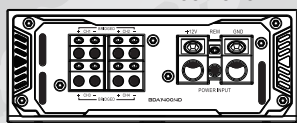

HDPro4 BAGGER KIT - PARTS

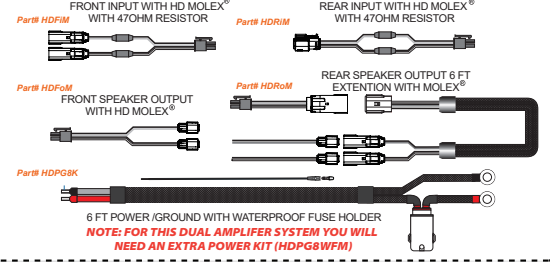

IN BAGS

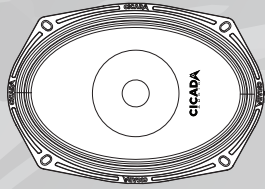

CH69.2 - 2 ohm - 6" x 9" CoAx Horns

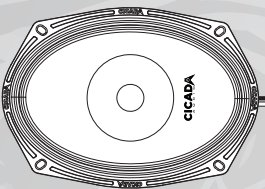

Part# HDROM OPTIONAL:
REAR SPEAKER OUTPUT 6 FT
EXTENSION WITH MOLEX

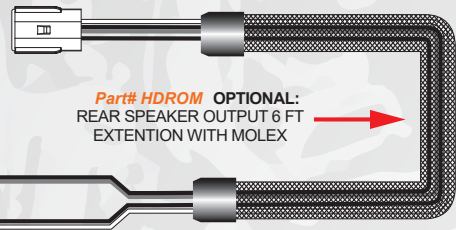



4 CHANNEL / 1 AMP SYSTEM W / COMPONENT & HORNS

FADES - 4 CHANNEL INPUT (MUST BE FLASHED OR STOCK 4CH SETUP)



Part# HDFiM OPTIONAL:
FRONT INPUT WITH HD MOLEX®
WITH 47 OHM RESISTOR

NOTE:
FULL POWER CURRENT DRAW
OF A BDA1100.4D IS
120 AMPERES!
BDA1400.4D IS
160 AMPERES
BDA2000.4D IS
240 AMPERES

PHYSICS! NOT MY FAULT!!

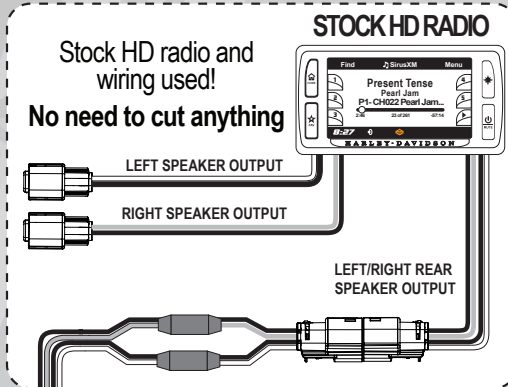

Stock HD radio and wiring used!
No need to cut anything

Part# HDRiM OPTIONAL:
REAR INPUT WITH HD MOLEX®
WITH 47OHM RESISTOR

BDA1000/1400/2000.4D
AMPLIFIER

INPUT SIDE

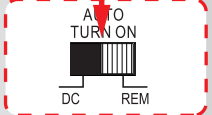

WITH NO SWITCHED 12V REMOTE OUT
USE "VOX" AS THE TURN ON SELECTION

IN FAIRING

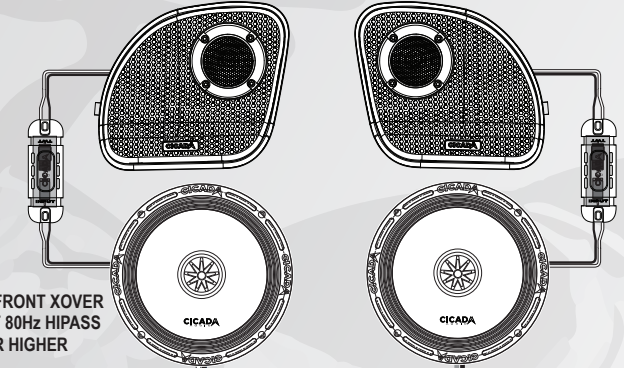

NOTE: FRONT COVER
SET AT 80Hz HIPASS
OR HIGHER

Stock HD speaker wiring
Just plug in to our harness
(HDPro4K Harness Kit Optional)

Part# HDFoM OPTIONAL:
FRONT SPEAKER OUTPUT
WITH HD MOLEX®

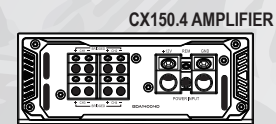

OUTPUT SIDE

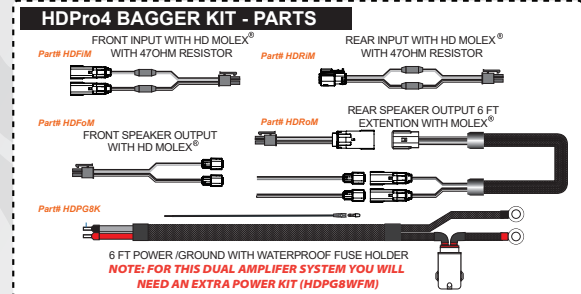

6 FT POWER /GROUND WITH WATERPROOF FUSE HOLDER
NOTE: FOR THIS DUAL AMPLIFIER SYSTEM YOU WILL
NEED AN EXTRA POWER KIT (HDPG8WFM)

Part# HDROM OPTIONAL:
REAR SPEAKER OUTPUT 6 FT
EXTENSION WITH MOLEX®

IN BAGS

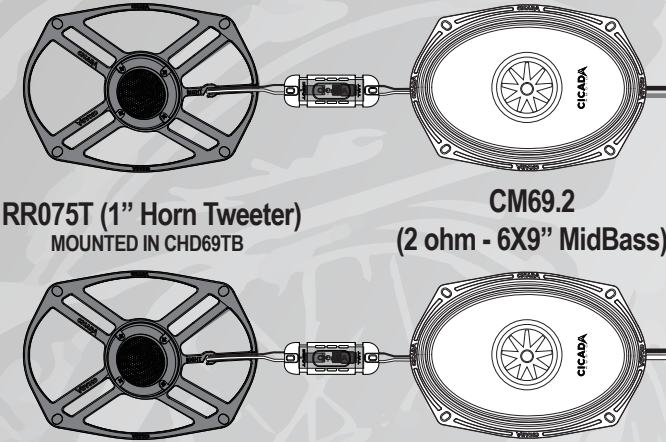

NOTE: REAR COVER
SET AT 60Hz HIPASS
OR HIGHER

**NOTE: WE HIGHLY RECOMMEND A DSP (LIKE OUR DSP88)
TO HELP CORRECT INPUT AND OUTPUT EQ ISSUES - NOT SHOWN**



8 CHANNEL / 2 AMP SYSTEM COMPONENT & HORNS W / DSP

2 - 4 CHANNEL AMPLIFIERS
ONE BRIDGED WITH PRO MIDBASS IN BAGS

IN FAIRING

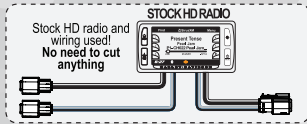
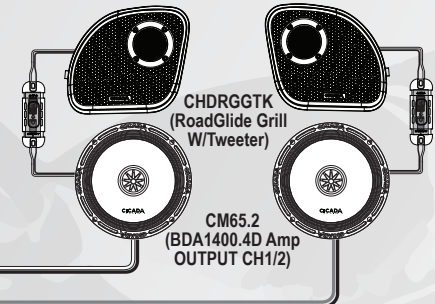

DSP88 INPUT:
FRONT INPUT WITH
HD MOLEX WITH
47 OHM RESISTOR

DSP88 REAR INPUT:
REAR INPUT WITH
HD MOLEX WITH
47 OHM RESISTOR
(Can be used if bike is FLASHED)

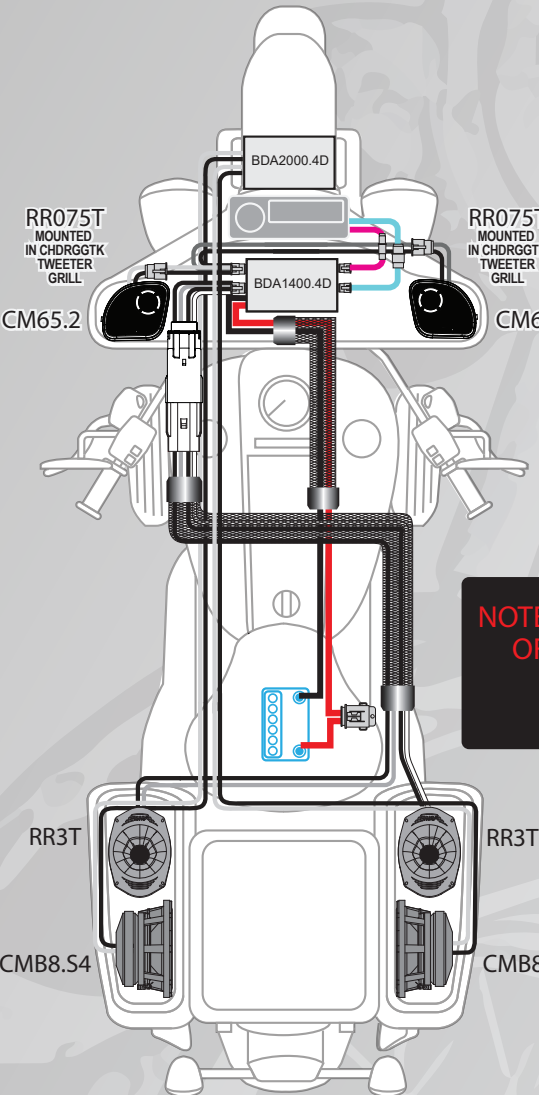

**NOTE: FULL POWER CURRENT DRAW
OF A BDA1400.4D/BDA2000.4D
IS 396 AMPERES!
PHYSICS! NOT MY FAULT!!**

IN BAG

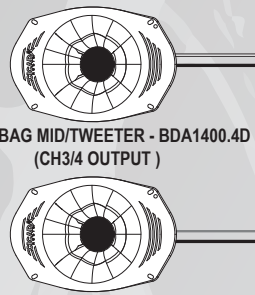

BDA1400.4D (Fairing/Bag Mid/Tweeter Amp)

AMP 1

BDA1400.4D
(Fairing MidBassTweeter Bag OUTPUT CH1/2/3/4)

CX150.4D (Fairing Mid
OUTPUT CH1/2)

AMP 2

BDA2000.4D
(Bag MidBass Amp Bridged OUTPUT CH7/8)

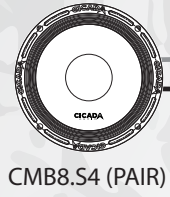



FINAL SETTINGS AND YOUR DONE!!

At this point you are pretty much done, My recommendation is that you live with the initial setup for a week and THEN make adjustments.

Also do not spend too much time “tweaking” the system. Once you have gains set CORRECTLY and have Checked “Phase” acoustically (with a Phase Meter - which is built into the AudioTools APP) Spend LESS than 45 minutes EQing your system.

Then take a break as your ears and brain will be charcoal!!

Rest your ears over night and listen again in the morning.

45 minutes is plenty of time to get a system initially “dialed in”.

You need to “live” with it for a bit BEFORE randomly changing settings.

Remember to play the music YOU listen to and not some “Artsy Fartsy” Audiophile recordings that you NEVER listen to!

Also make sure whatever recordings you listen to are as “HiRes” as possible and NOT 128mps MP3’s!!!!

**POWER IS NOT CREATED BY PIXIE DUST!!!
YOU NEED CURRENT TO MAKE POWER
....PERIOD**

**Like our President, Larry, always tells people.
...there is NO Fairies...Pixies Dust...or Unicorns!!!
Its ALL physics...NOT MY FAULT !!!**

**IF YOU HAVE ANY ISSUES DO NOT
HESITATE TO CALL !
1-480-887-8699
OR EMAIL@
cs@cicadaaudio.com**

website: www.cicadaaudio.com

LIMITED WARRANTY STATEMENT:

Cicada Audio warrants this product to be free of defects and quality workmanship for a period of TWO (2) year from the original date of purchase. A receipt from an authorized Cicada Audio dealer is required for warranty claim. Product warranty starts on the day of purchase or no longer than three years from the date of manufacture.

THIS WARRANTY IS NON-TRANSFERABLE AND APPLIES ONLY TO THE ORIGINAL PURCHASER OF THE PRODUCT IN THE ORIGINAL INSTALLATION.

Should a manufacturing defect occur during the warranty period, Cicada Audio will repair or replace defective product with a product of the same or equivalent value and performance. Damage or failure caused by improper use is not covered under this warranty. Negligence, improper use, product modification, unauthorized repair, accident, acts of god, dealer misrepresentation and improper or inadequate packaging during return shipment will not be covered. Warranty is void if serial numbers have been removed or defaced.

HOW TO OBTAIN WARRANTY SERVICE:

In the event a Cicada Audio product should require service, you should return to your authorized Cicada Audio retailer. All claims must follow the guidelines listed above and be returned with a copy of the original sales receipt.

Product returned for warranty service must be freight prepaid, properly packaged, and clearly marked with the Return Authorization (RA) number issued by Cicada Audio. Products that are returned and are improperly packaged, do not have an RA number clearly marked on the package, or have never been issued an RA number may be refused upon delivery. Cicada does not assume responsibility for lost or mis-labelled products.

Repair or replacement under this warranty is the exclusive remedy of the consumer. Cicada Audio shall not be liable for any incidental or consequential damages for breach of any expressed or implied warranty on this product. Certain states do not allow the exclusion of limitation of incidental or consequential damages, allow limitations on how long an implied warranty lasts, so the above limitations or exclusions may not apply to you. This warranty gives you specific legal rights and you may also have other rights that may vary from state to state.

For factory service OR tech support contact:

Cicada Audio
3757 E Broadway Road, Suite 5
Phoenix, AZ 85040
Phone: 480-887-8699

cs@cicadaaudio.com